

T UVUÜÖÖWSVUÜKNMRV-030-63B14

WIDOK 3D



PRODUCT DESCRIPTION:

Worm geared motor fitted for motor coupling version PAM with sleeve

PRODUCT TYPE: NMRV

CONFIGURATION & DIMENSIONAL VALUES

GR Size	030
PAM Input PAM flange	63 B14
ACU Output hole shaft (d)	14
VB Double input shaft	NO
TFU Output flange gear unit 2	NO
DFU Output flange dimension (d)	-
PFU Output flange position	-
AL Output hole shaft (d)	NO
PAL Output shaft position	-
BR Torque arm	NO
PBR Torque arm position	-
CAP Cover	NO
TIP Motor type	T-Three phase
GRA Motor size	063
RAF Cooling	IC411-Self-Ventilated
FC Motor execution	B14
TF Break type	-
AF Brake power supply	-
COP Terminal box cover	Aluminium
CVE Fan cover	Standard
MOR Terminal box cover position	1
A	54
AC	121
B	20
B1	3
BB	5
BM	4
BM1	4
D	14
D1	9

PRODUCT DESCRIPTION:

Worm geared motor fitted for motor coupling
version PAM with sleeve

PRODUCT TYPE: NMRV

CONFIGURATION & DIMENSIONAL VALUES

DM	11
DM1	11
E	23
F	-
FF	M4x10
G	55
G1	63
H	40
I	30
K	44
KE	M6x11(4)
L	56
LB	188
LL	211
M	65
N	55
N1	29
O	6.5
P	75
PM	90
PM1	90
Q	44
R	57
S	5.5
T	21
T1	10.2
TM	12.8
TM1	12.5
TT	16.3
V	27
W	0°

2D VIEW PRA

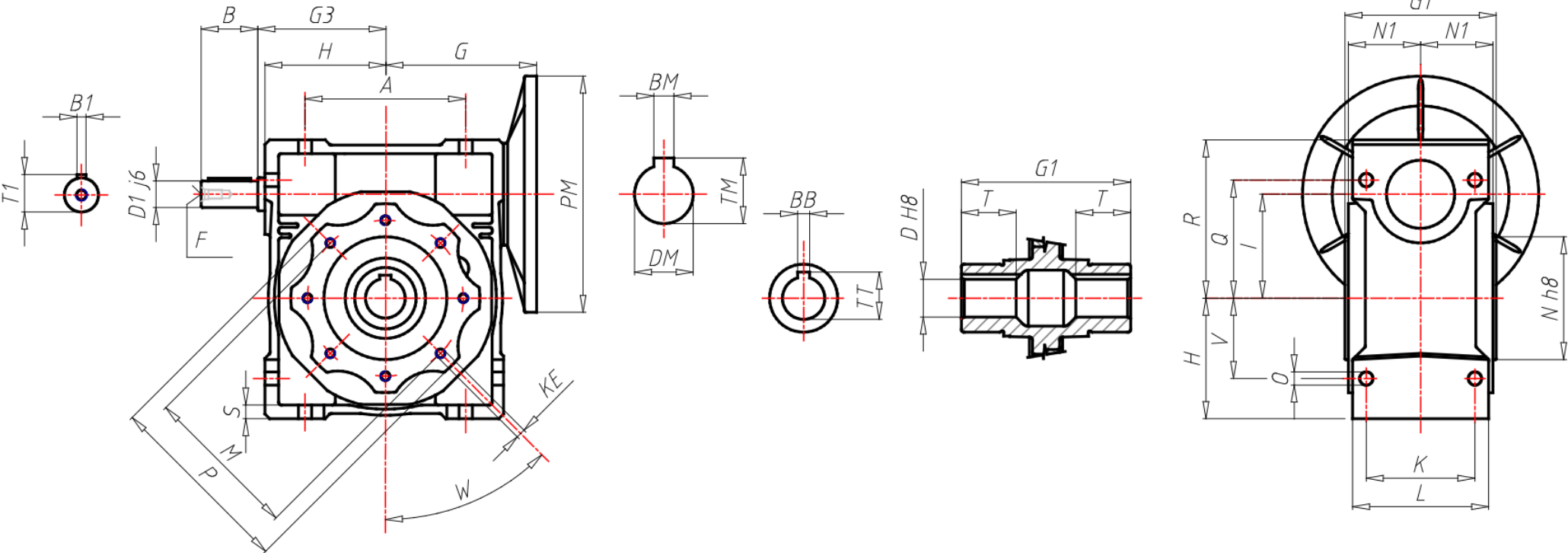

PRODUCT DESCRIPTION:

Worm geared motor fitted for motor coupling version PAM with sleeve

PRODUCT TYPE: NMRV

2D VIEW ACCESSORIES

