

F1	-
FF	M10
FF1	-
G	124.5
G2	86
H	80
H1	-
I	-
II	90
K	13
L	-
M	-
M1	110
M2	120
N	-
NN	145
O	9
P	-
PM	200
PM1	-
Q	75
R	111
S	10
SS	15
T	-
TM	21.8
TM1	-
TT	28
V	-
W	152
X	-
Y	-

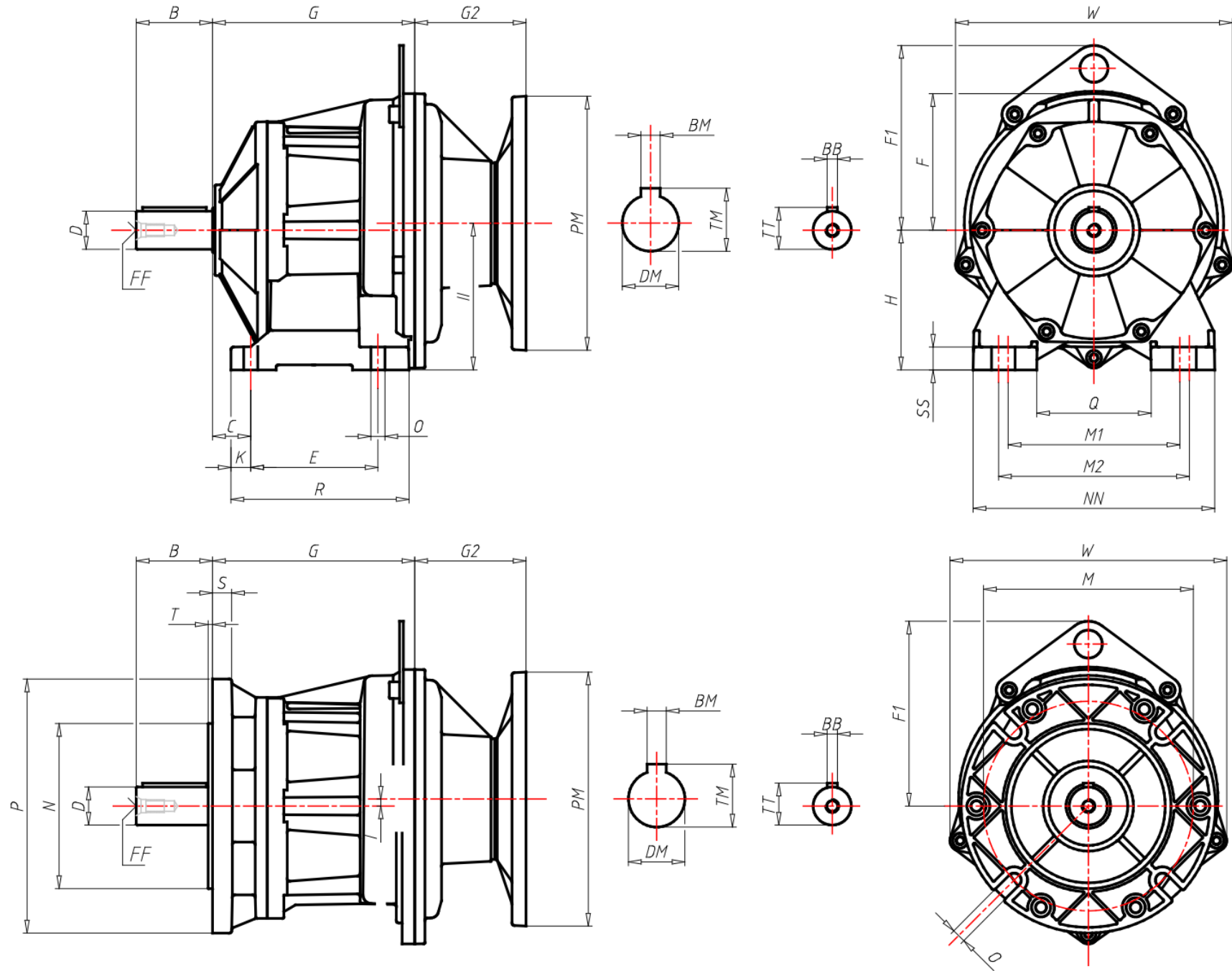

ΑΙΣΘΗΤΗΡΕΣ

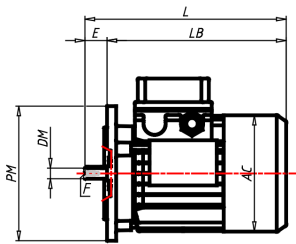

B5

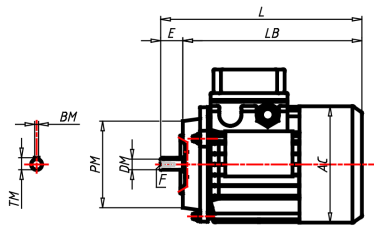

B14

