

ÖÖË ÒÁÒÔÏ ÒÏÏ ÒÁÏ ÏÏÏ

GR Size	143
VERS Gear box version	T-With Feet
RAP Ratio	
PAM Input PAM flange	180 B5
ACU1 Output shaft (d*I)	90x170
TFU Output flange	-
DFU Output flange dimension (d)	-
TIP Motor/Inverter Motor	No
GRA Motor size	-
ALI Supply	-
GIRI Speed Range	-
POTE Power Group	-
CTRL Manual Adjustment Control	-
MODU Expansion modules	-
RAF Cooling	-
FC Motor execution	-
TF Break type	-
AF Brake power supply	-
COP Terminal box cover	-
CVE Fan cover	-
MOR Terminal box cover position	-
A	124
B	170
BB	25
BM	14
BM1	-
C	50
D Output shaft (d*I)	90
DM	48
DM1	-
E	410

EE	-
F	490
FF	M20
FF1	-
G	430
G1	-
H	315
I	45
K	40
L	-
M	340
N	450
O	26
PM	350
PM1	-
Q	236
R	490
S	35
TM	51.8
TM1	-
TT	95
X	-
Y	-

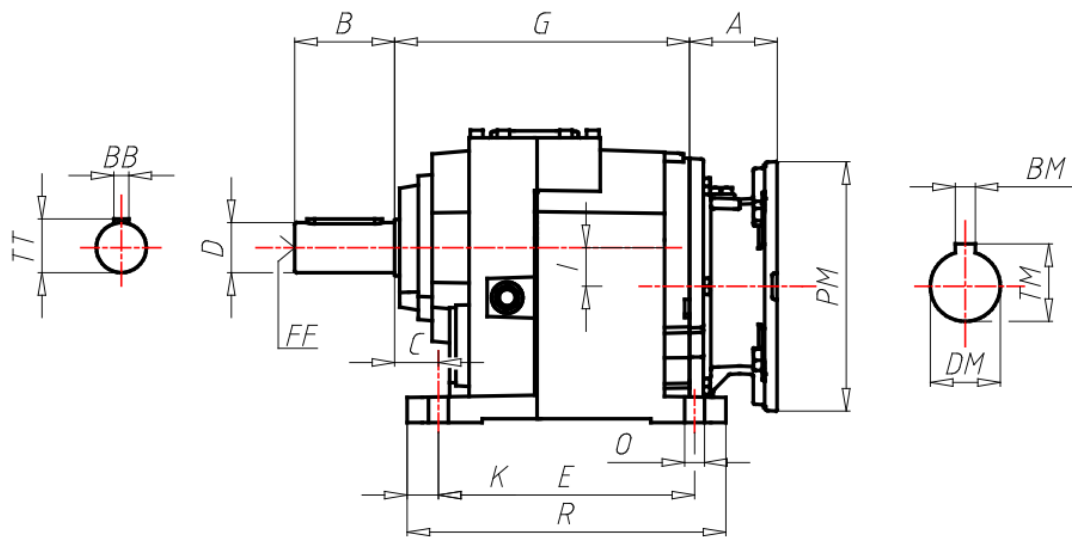

H/PH...T

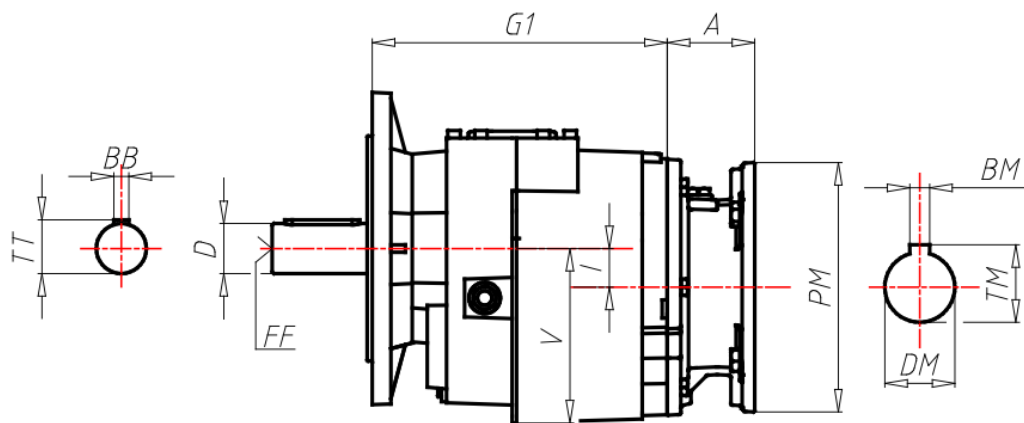
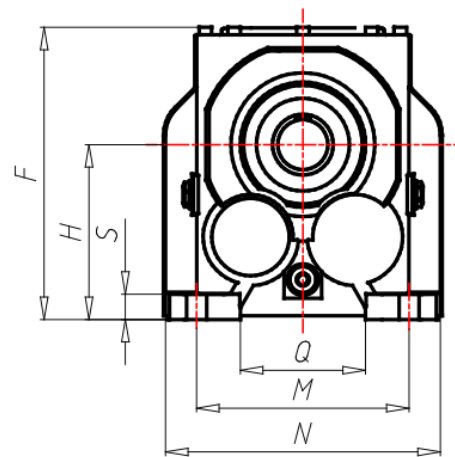

H/PH...F

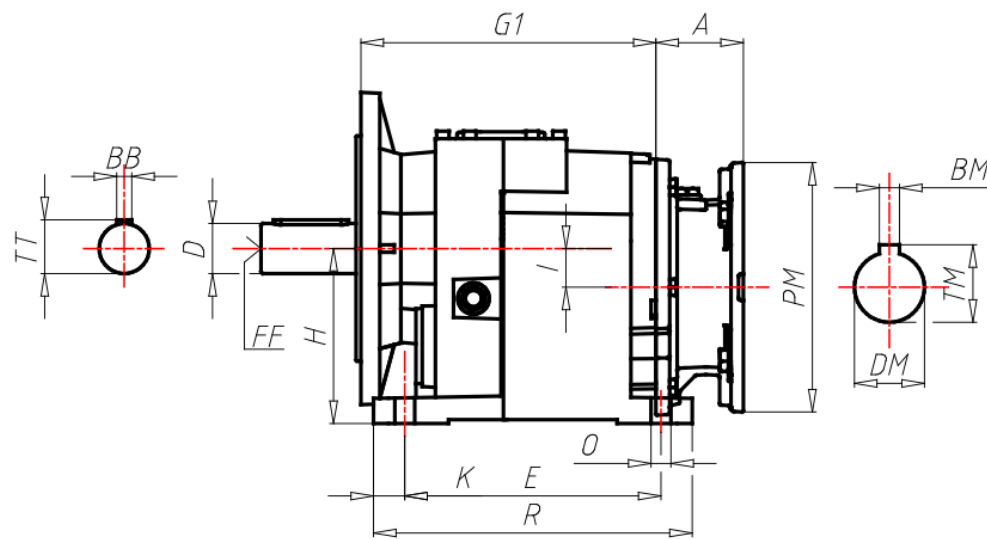

H/PH...U

ΑΞΟΝΟΔΕΞΗ

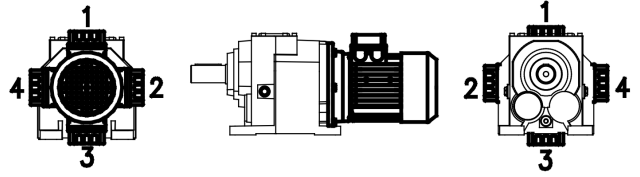
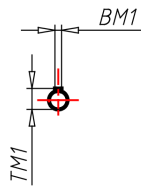
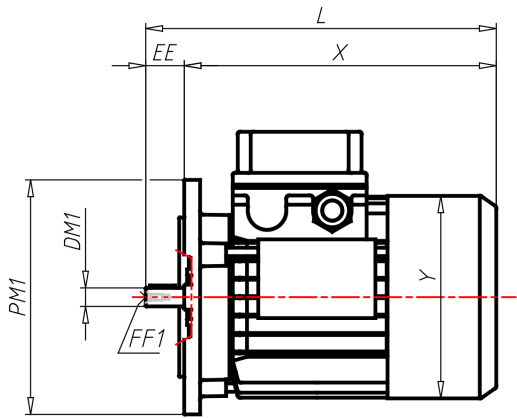

B5