

ÖÖË ÒÁÒÔÏ ÒÏÏ ÒÁÏ ÏÏÏ

GR Size	122
VERS Gear box version	T-With Feet
RAP Ratio	
PAM Input PAM flange	160 B5
ACU1 Output shaft (d*I)	70x140
TFU Output flange	-
DFU Output flange dimension (d)	-
TIP Motor/Inverter Motor	No
GRA Motor size	-
ALI Supply	-
GIRI Speed Range	-
POTE Power Group	-
CTRL Manual Adjustment Control	-
MODU Expansion modules	-
RAF Cooling	-
FC Motor execution	-
TF Break type	-
AF Brake power supply	-
COP Terminal box cover	-
CVE Fan cover	-
MOR Terminal box cover position	-
A	148
B	140
BB	20
BM	12
BM1	-
C	45
D Output shaft (d*I)	70
DM	42
DM1	-
E	370

EE	-
F	399
FF	M20
FF1	-
G	376.5
G1	-
H	250
I	47.5
K	35
L	-
M	290
N	406
O	26
PM	350
PM1	-
Q	193
R	440
S	35
TM	45.3
TM1	-
TT	74.5
X	-
Y	-

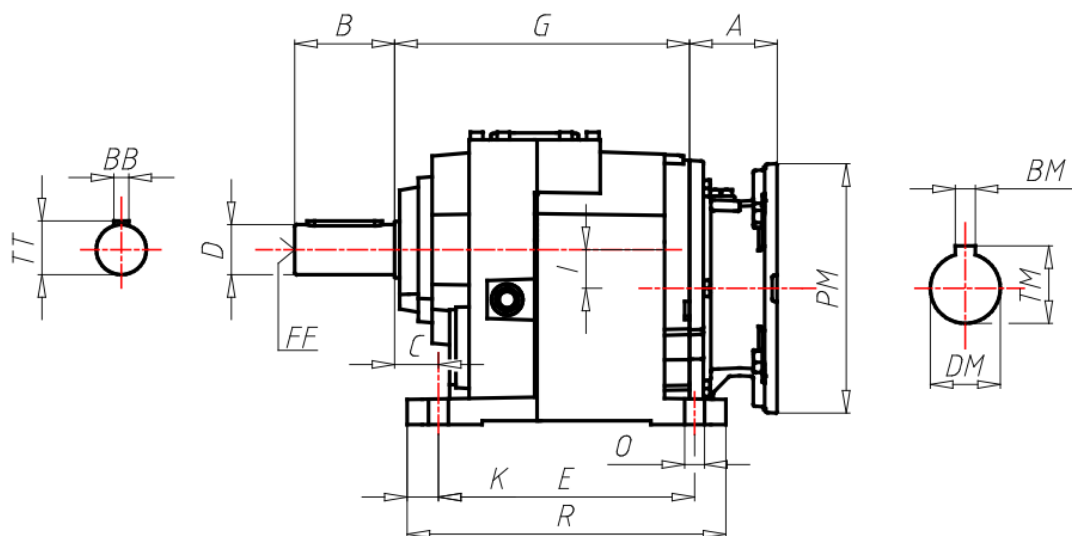

H/PH...T

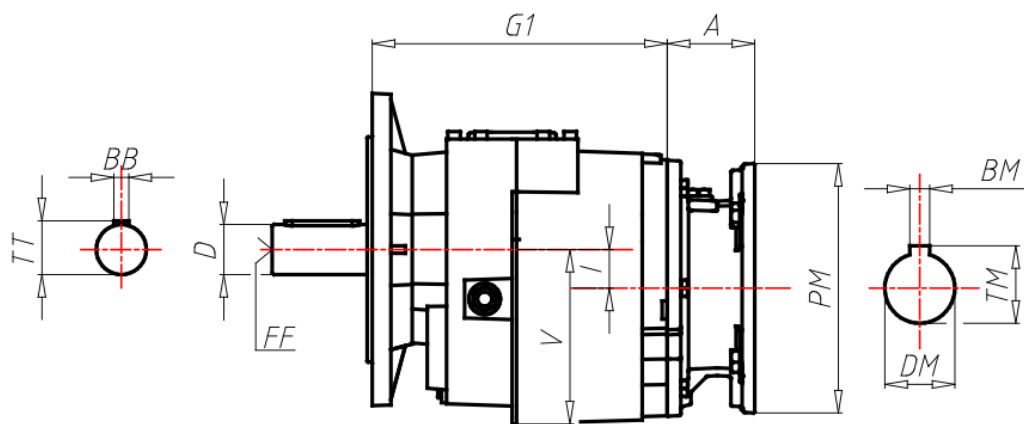
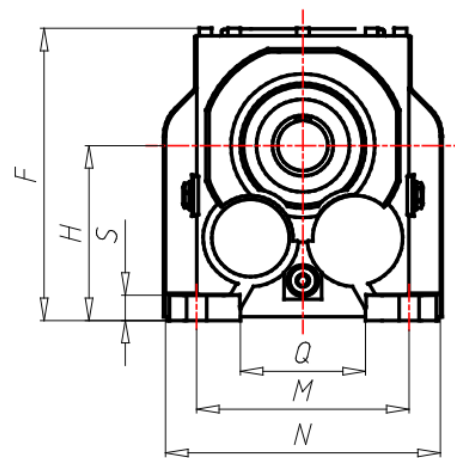

H/PH...F

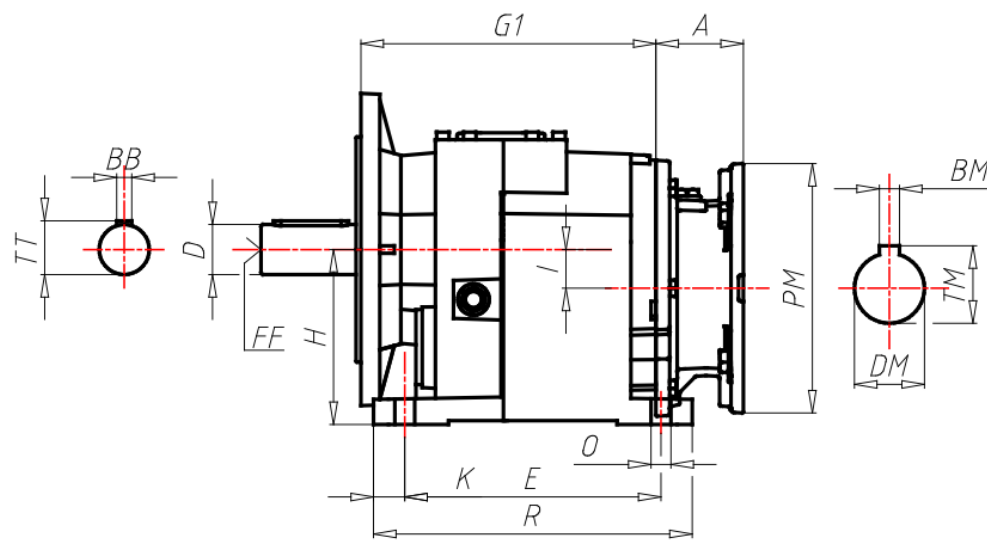

H/PH...U

ΑΕΣΟΔΟΥΣ

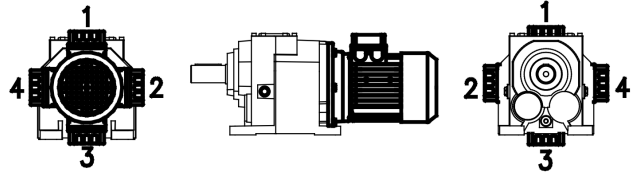
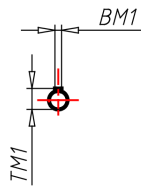
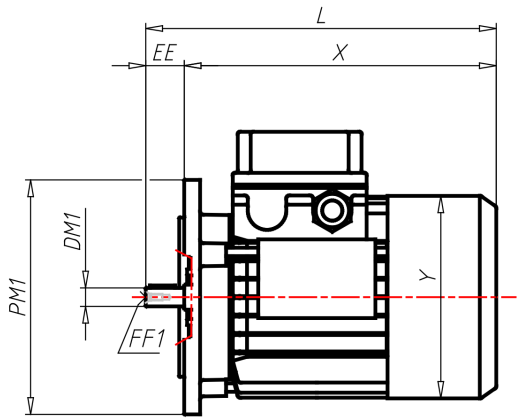

B5