

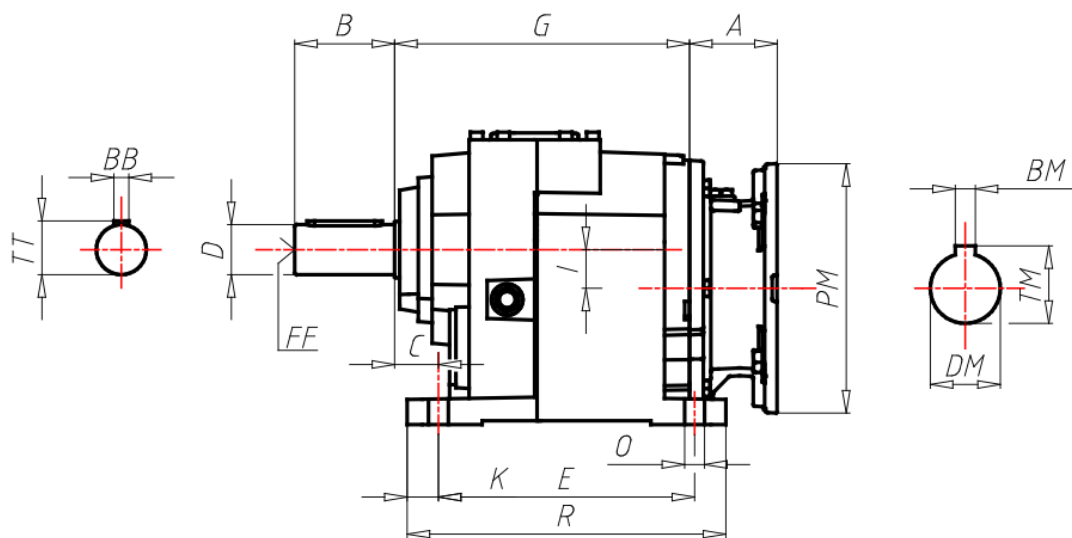

## ÖÖË ÒÁÒÔÏ ÒÏÏ ÒÁÏ ÏÏÏ

<b>GR Size</b>	122
<b>VERS Gear box version</b>	T-With Feet
<b>RAP Ratio</b>	
<b>PAM Input PAM flange</b>	132 B5
<b>ACU1 Output shaft (d*I)</b>	70x140
<b>TFU Output flange</b>	-
<b>DFU Output flange dimension (d)</b>	-
<b>TIP Motor/Inverter Motor</b>	No
<b>GRA Motor size</b>	-
<b>ALI Supply</b>	-
<b>GIRI Speed Range</b>	-
<b>POTE Power Group</b>	-
<b>CTRL Manual Adjustment Control</b>	-
<b>MODU Expansion modules</b>	-
<b>RAF Cooling</b>	-
<b>FC Motor execution</b>	-
<b>TF Break type</b>	-
<b>AF Brake power supply</b>	-
<b>COP Terminal box cover</b>	-
<b>CVE Fan cover</b>	-
<b>MOR Terminal box cover position</b>	-
<b>A</b>	101
<b>B</b>	140
<b>BB</b>	20
<b>BM</b>	10
<b>BM1</b>	-
<b>C</b>	45
<b>D Output shaft (d*I)</b>	70
<b>DM</b>	38
<b>DM1</b>	-
<b>E</b>	370

<b>EE</b>	-
<b>F</b>	<b>399</b>
<b>FF</b>	<b>M20</b>
<b>FF1</b>	-
<b>G</b>	<b>376.5</b>
<b>G1</b>	-
<b>H</b>	<b>250</b>
<b>I</b>	<b>47.5</b>
<b>K</b>	<b>35</b>
<b>L</b>	-
<b>M</b>	<b>290</b>
<b>N</b>	<b>406</b>
<b>O</b>	<b>26</b>
<b>PM</b>	<b>300</b>
<b>PM1</b>	-
<b>Q</b>	<b>193</b>
<b>R</b>	<b>440</b>
<b>S</b>	<b>35</b>
<b>TM</b>	<b>41.3</b>
<b>TM1</b>	-
<b>TT</b>	<b>74.5</b>
<b>X</b>	-
<b>Y</b>	-



H/PH...T

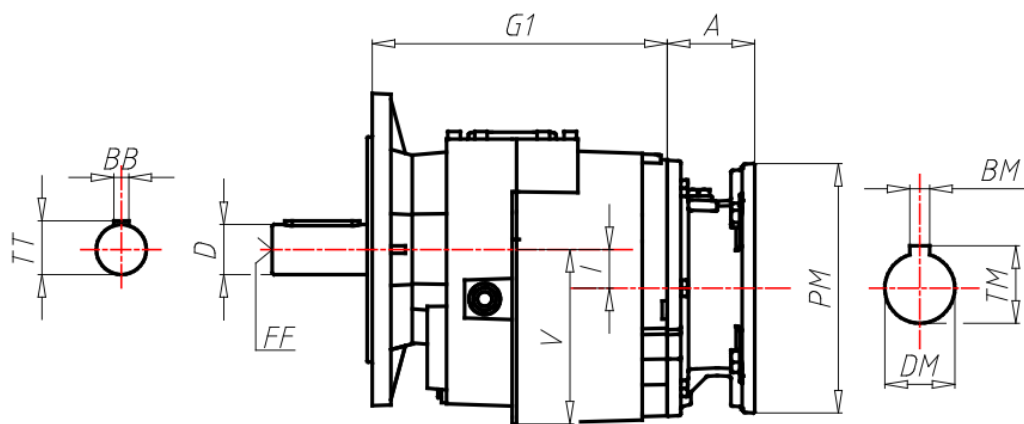

H/PH...F

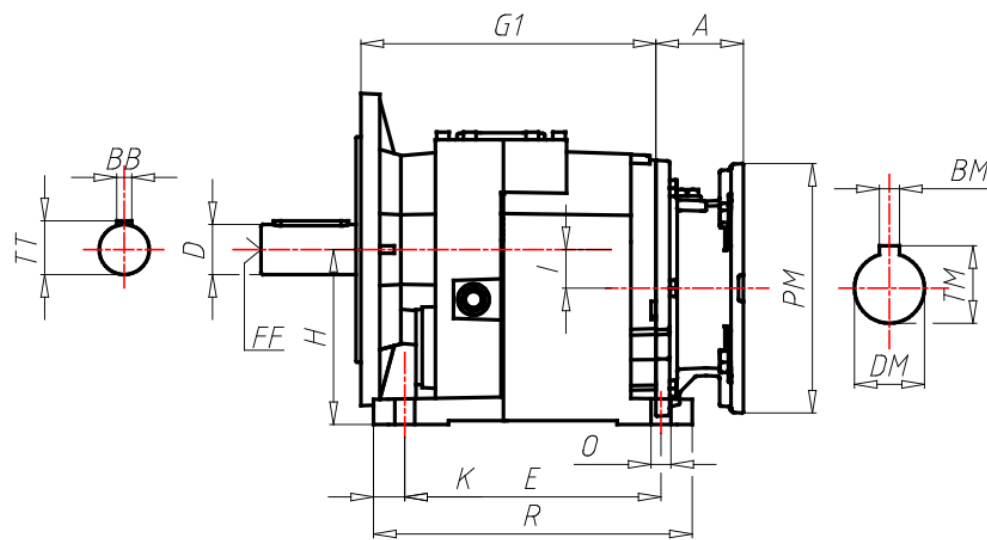

H/PH...U

ΑΕΣΟΔΟΥΣ

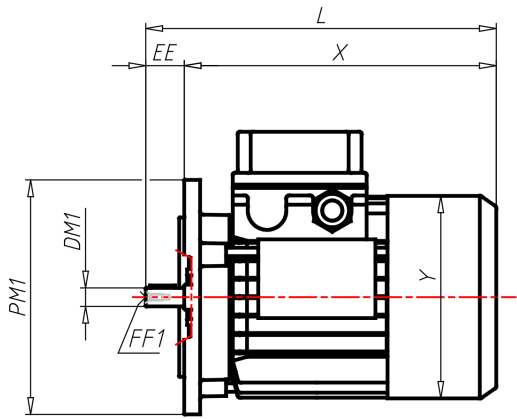

B5

