

ÖÖË ÒÁÒÔÏ ÒÏÏ ÒÁÏ ÏÏÏ

GR Size	062
VERS Gear box version	T-With Feet
RAP Ratio	
PAM Input PAM flange	80 B5
ACU1 Output shaft (d*I)	40x80
TFU Output flange	-
DFU Output flange dimension (d)	-
TIP Motor/Inverter Motor	No
GRA Motor size	-
ALI Supply	-
GIRI Speed Range	-
POTE Power Group	-
CTRL Manual Adjustment Control	-
MODU Expansion modules	-
RAF Cooling	-
FC Motor execution	-
TF Break type	-
AF Brake power supply	-
COP Terminal box cover	-
CVE Fan cover	-
MOR Terminal box cover position	-
A	70
B	80
BB	12
BM	6
BM1	-
C	35
D Output shaft (d*I)	40
DM	19
DM1	-
E	205

EE	-
F	234
FF	M16
FF1	-
G	236
G1	-
H	140
I	31
K	25
L	-
M	170
N	220
O	16
PM	200
PM1	-
Q	100
R	255
S	20
TM	21.8
TM1	-
TT	43
X	-
Y	-

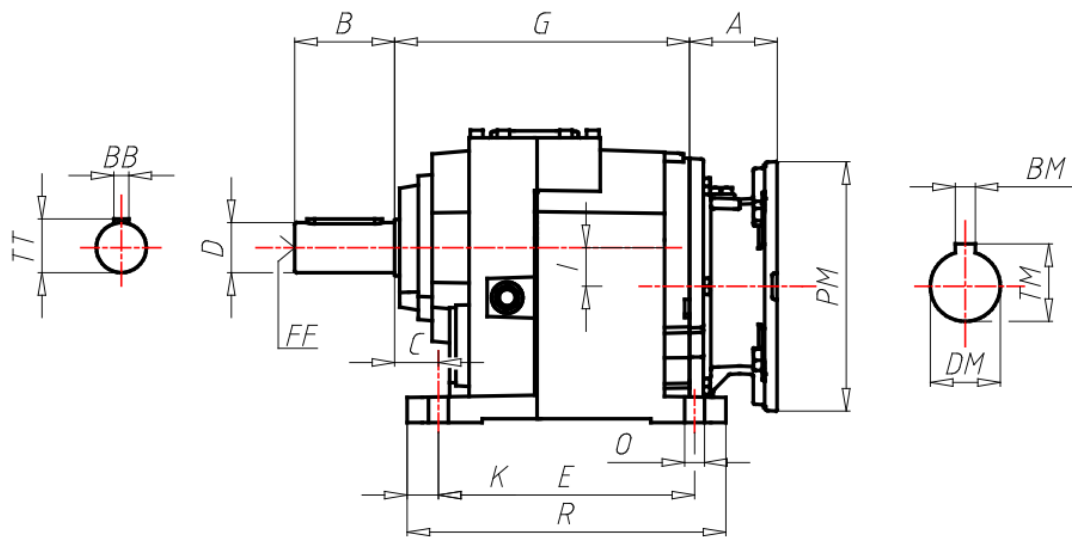

H/PH...T

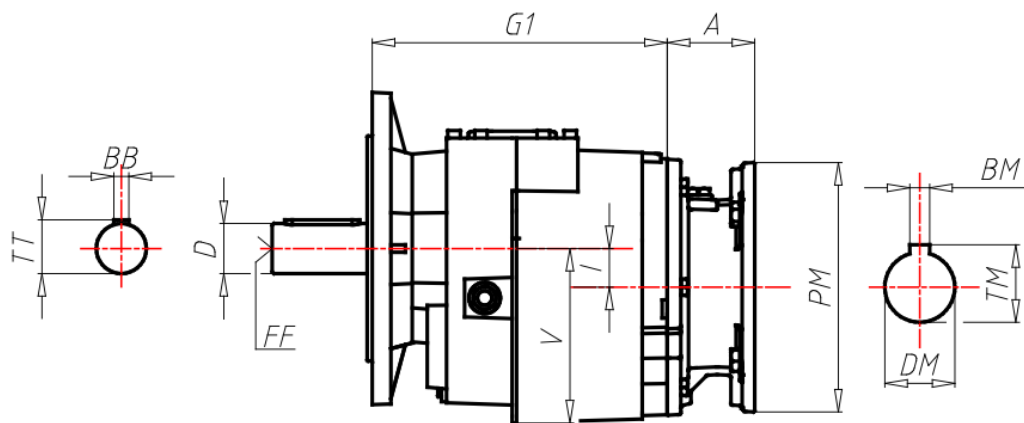

H/PH...F

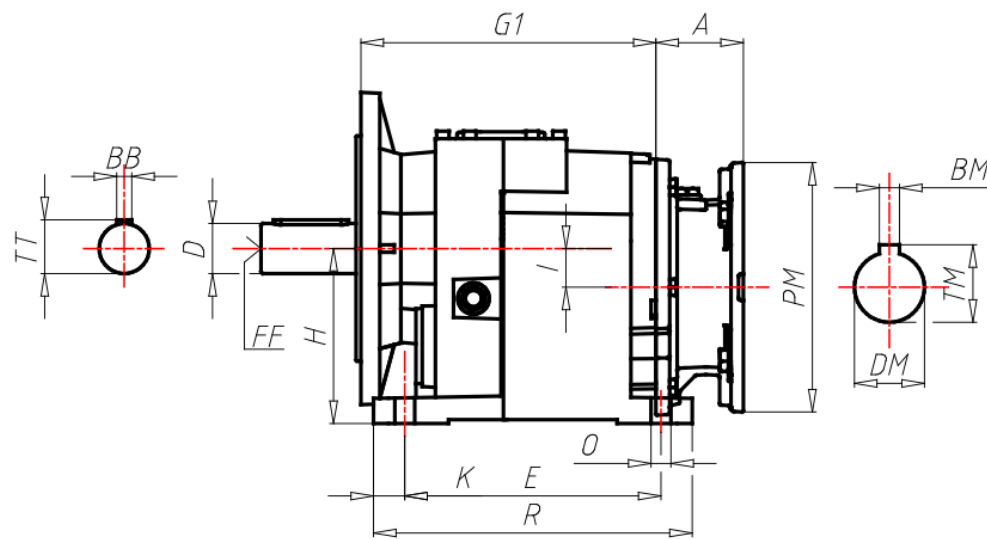

H/PH...U

ΑΞΟΝΟΔΕΞΗ

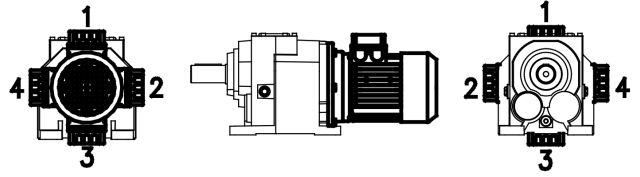
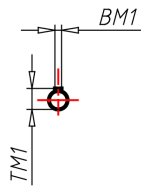
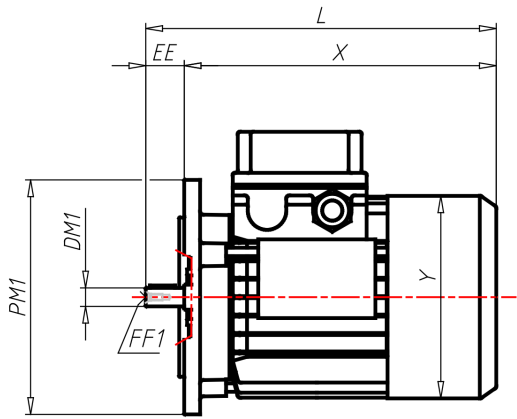

B5