

EE	-
F	192
FF	M12
FF1	-
G	187
G1	-
H	115
I	25.5
K	18
L	-
M	135
N	185
O	14
PM	200
PM1	-
Q	82
R	201
S	18
TM	21.8
TM1	-
TT	38
X	-
Y	-

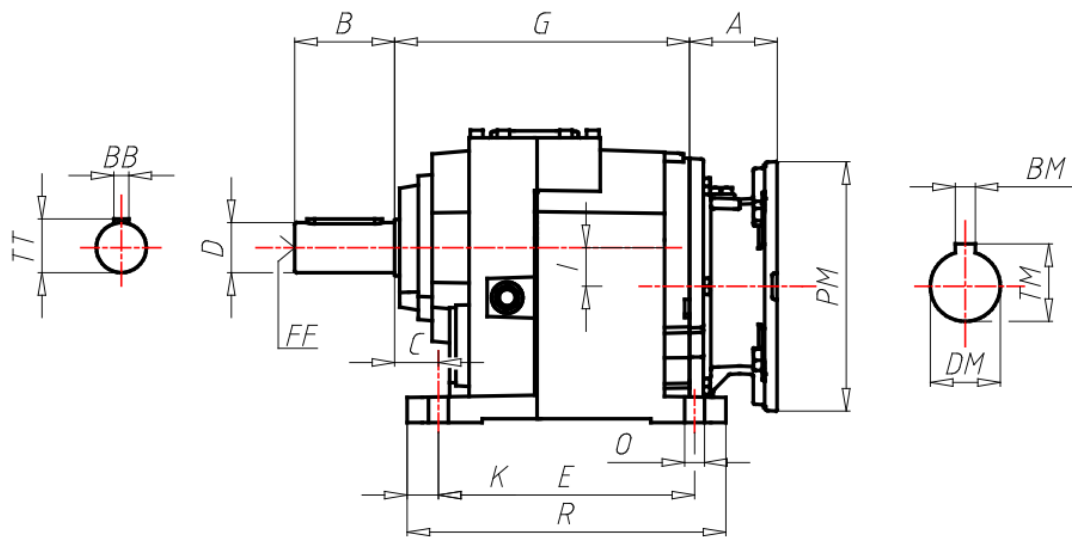

H/PH...T

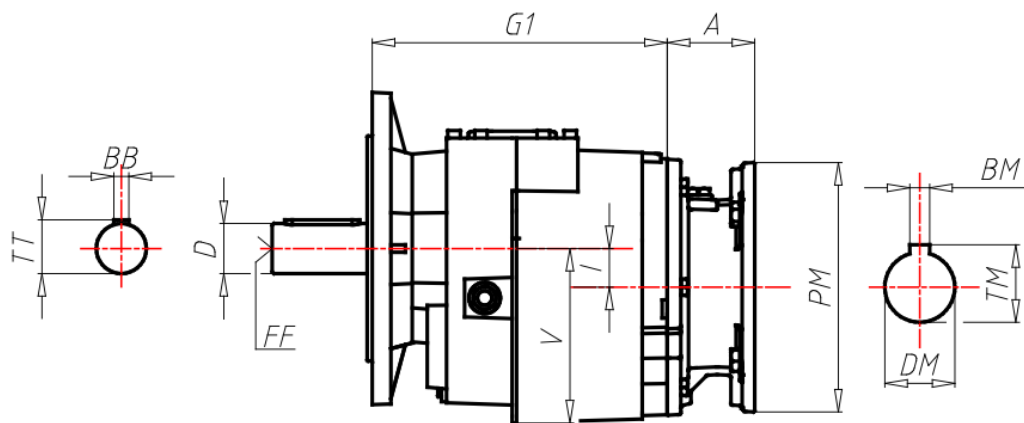

H/PH...F

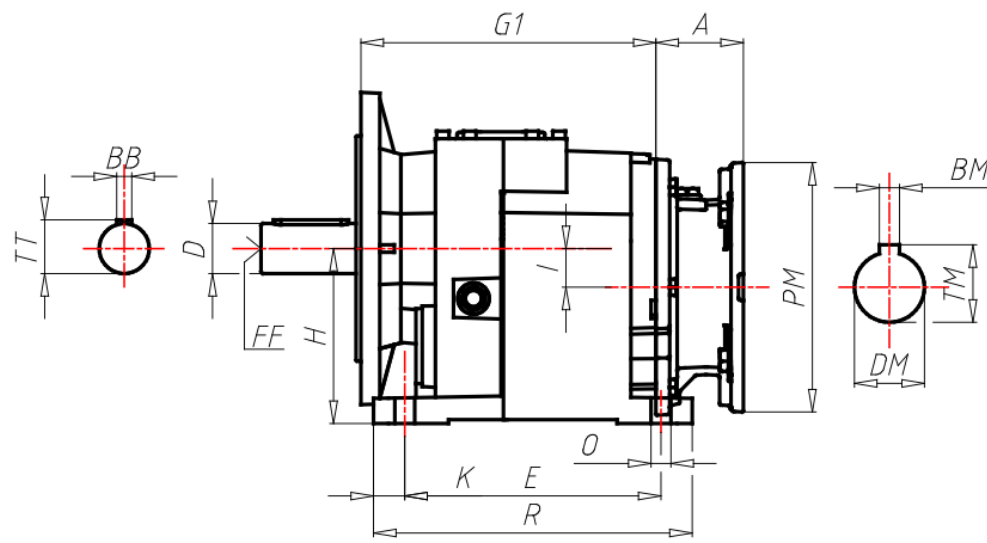

H/PH...U

ΑΞΟΝΟΔΕΞΗ

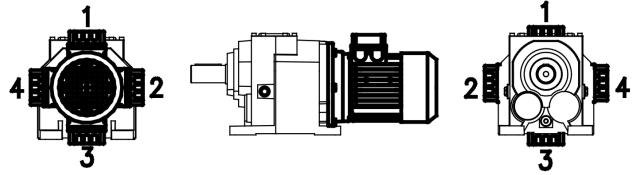
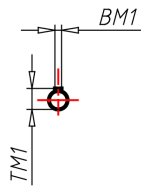
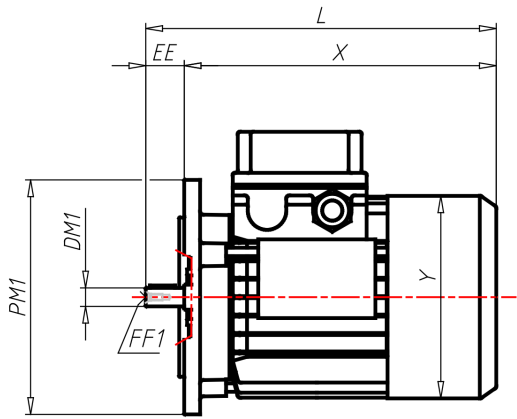

B5