

ÖÖË ÒÁÒÔÏ ÒÏÏ ÒÁÏ ÏÏÏ

GR Size	042
VERS Gear box version	T-With Feet
RAP Ratio	
PAM Input PAM flange	90 B5
ACU1 Output shaft (d*I)	30x60
TFU Output flange	-
DFU Output flange dimension (d)	-
TIP Motor/Inverter Motor	No
GRA Motor size	-
ALI Supply	-
GIRI Speed Range	-
POTE Power Group	-
CTRL Manual Adjustment Control	-
MODU Expansion modules	-
RAF Cooling	-
FC Motor execution	-
TF Break type	-
AF Brake power supply	-
COP Terminal box cover	-
CVE Fan cover	-
MOR Terminal box cover position	-
A	90
B	60
BB	8
BM	8
BM1	-
C	30
D Output shaft (d*I)	30
DM	24
DM1	-
E	165

EE	-
F	189
FF	M10
FF1	-
G	152
G1	-
H	115
I	18
K	15
L	-
M	135
N	170
O	14
PM	200
PM1	-
Q	86
R	195
S	15
TM	27.3
TM1	-
TT	33
X	-
Y	-

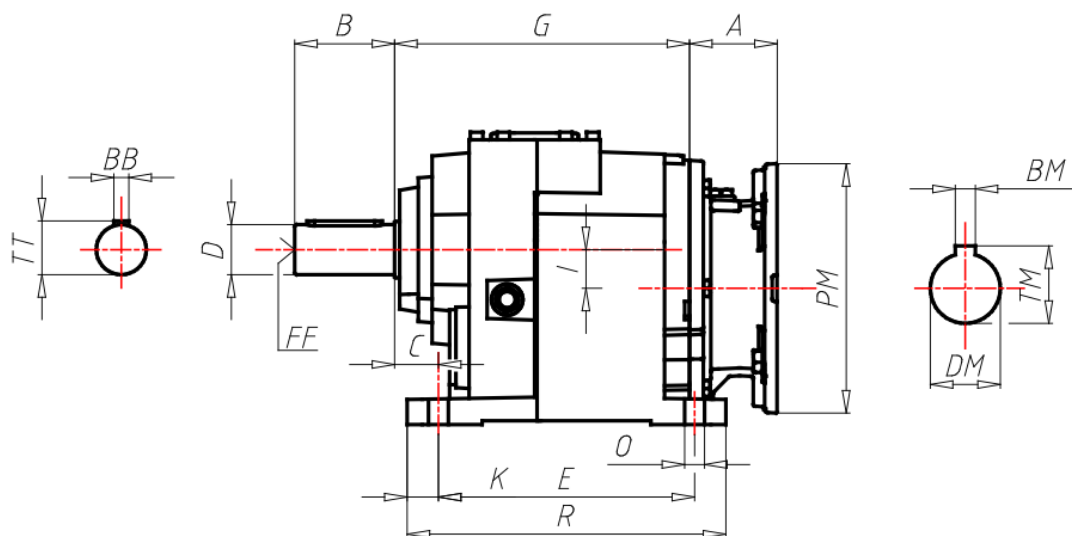

H/PH...T

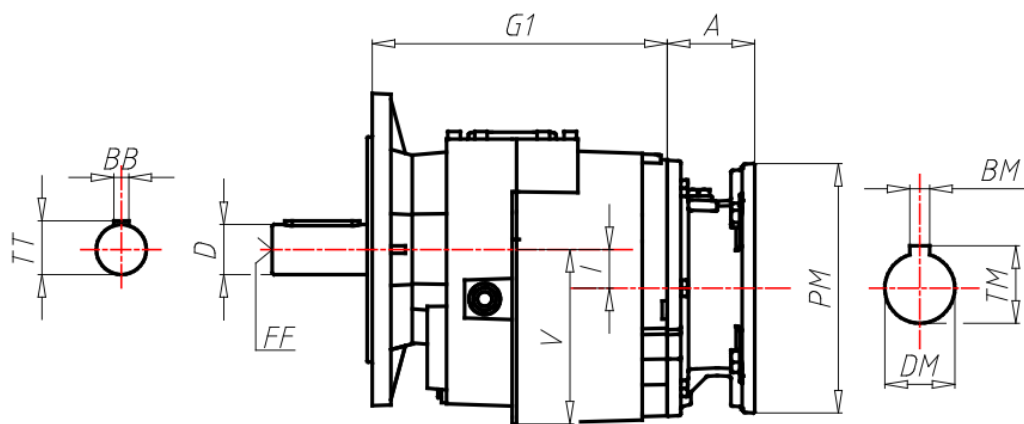

H/PH...F

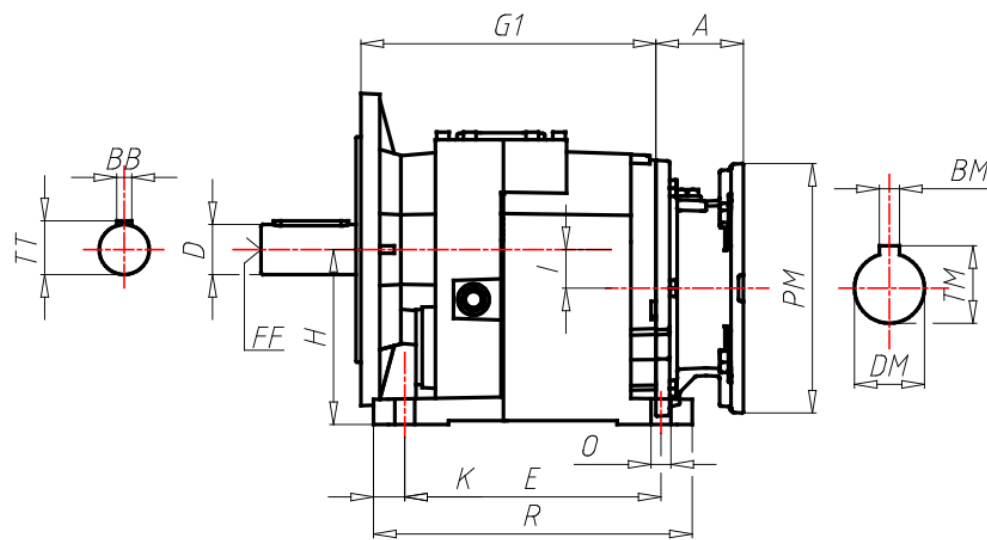

H/PH...U

ΑΞΟΝΟΔΕΞΗ

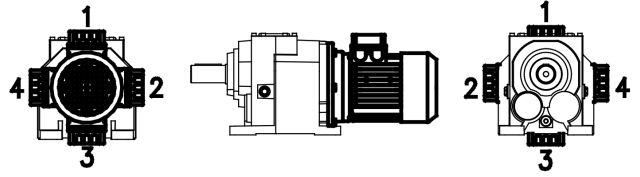
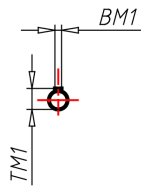
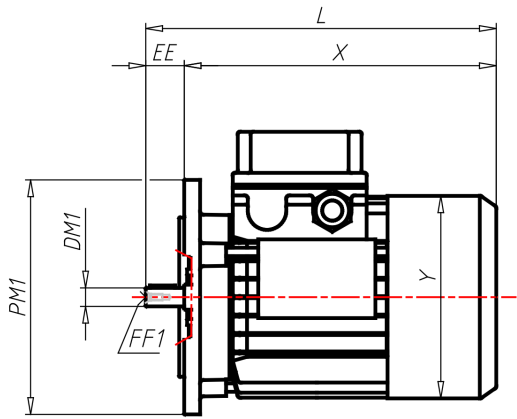

B5