

ÖÖË ÒÁÒÔÏ ÒÏÏ ÒÁÏ ÏÏÏ

GR Size	033
VERS Gear box version	T-With Feet
RAP Ratio	
PAM Input PAM flange	63 B5
ACU1 Output shaft (d*I)	25x50
TFU Output flange	-
DFU Output flange dimension (d)	-
TIP Motor/Inverter Motor	No
GRA Motor size	-
ALI Supply	-
GIRI Speed Range	-
POTE Power Group	-
CTRL Manual Adjustment Control	-
MODU Expansion modules	-
RAF Cooling	-
FC Motor execution	-
TF Break type	-
AF Brake power supply	-
COP Terminal box cover	-
CVE Fan cover	-
MOR Terminal box cover position	-
A	57
B	50
BB	8
BM	4
BM1	-
C	25
D Output shaft (d*I)	25
DM	11
DM1	-
E	130

EE	-
F	169
FF	M10
FF1	-
G	141
G1	-
H	90
I	9.2
K	15
L	-
M	110
N	140
O	11
PM	140
PM1	-
Q	61
R	160
S	15
TM	12.8
TM1	-
TT	28
X	-
Y	-

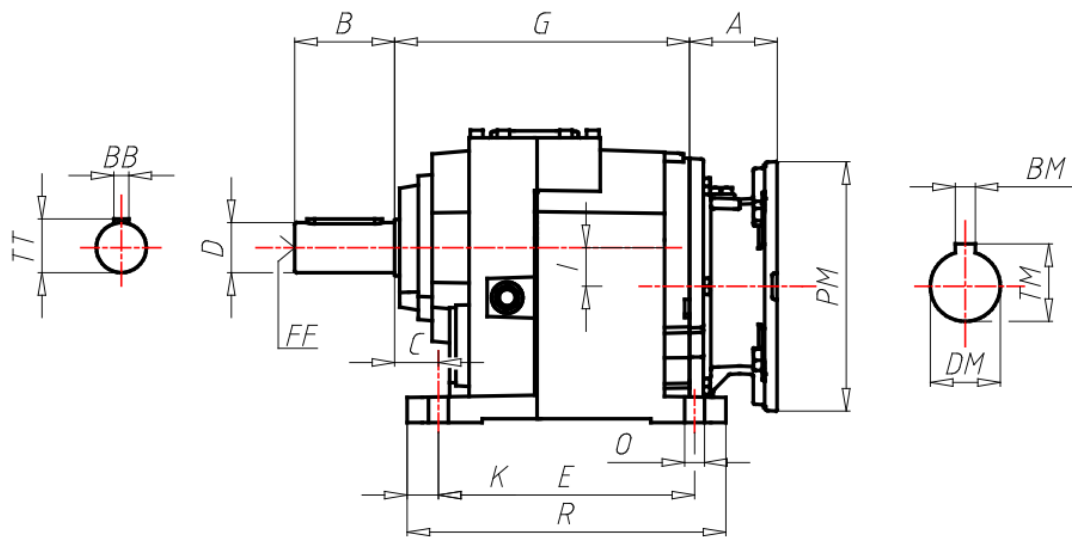

H/PH...T

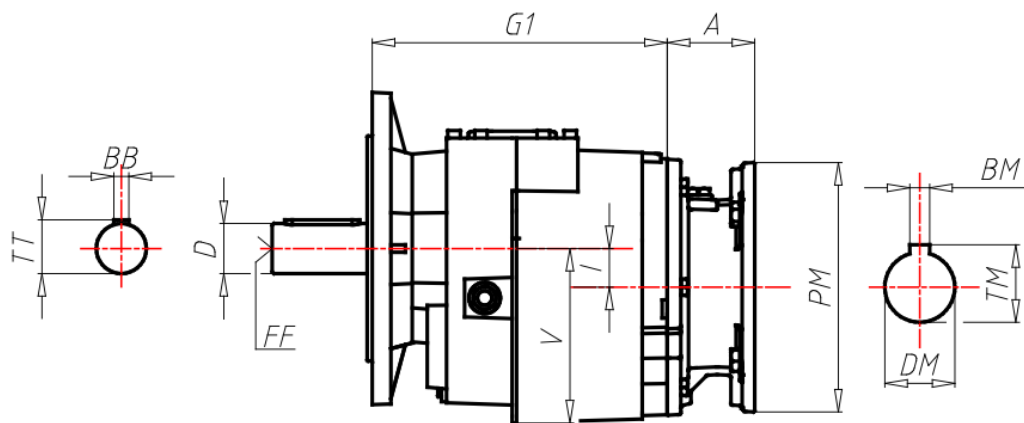
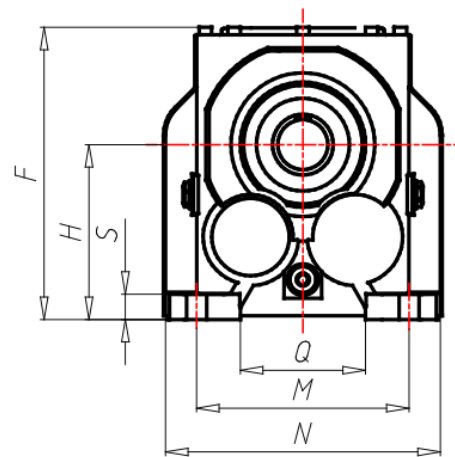

H/PH...F

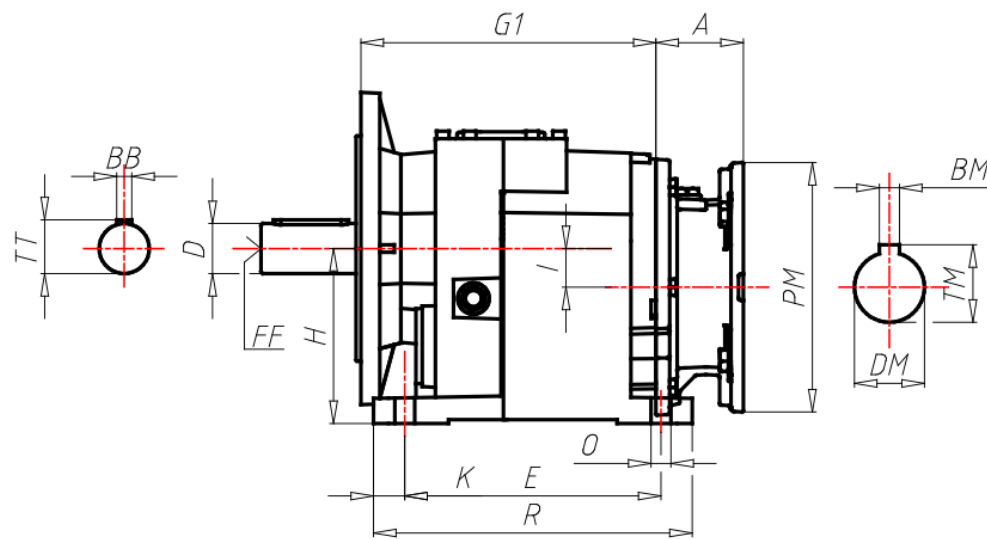

H/PH...U

ΑΞΟΝΟΔΕΞΗ

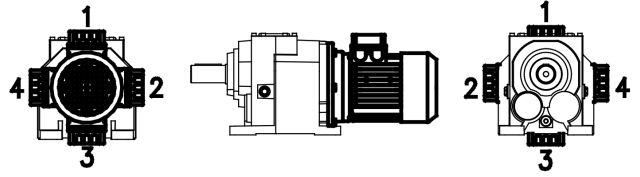
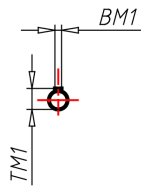
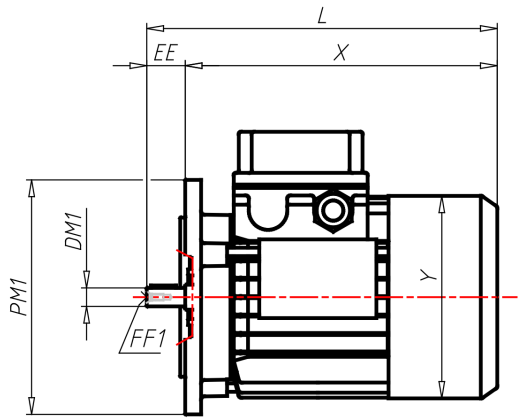

B5