

ÚÜZÒSýÖÞÖK NMRV-075-100-112B5

WIDOK 3D

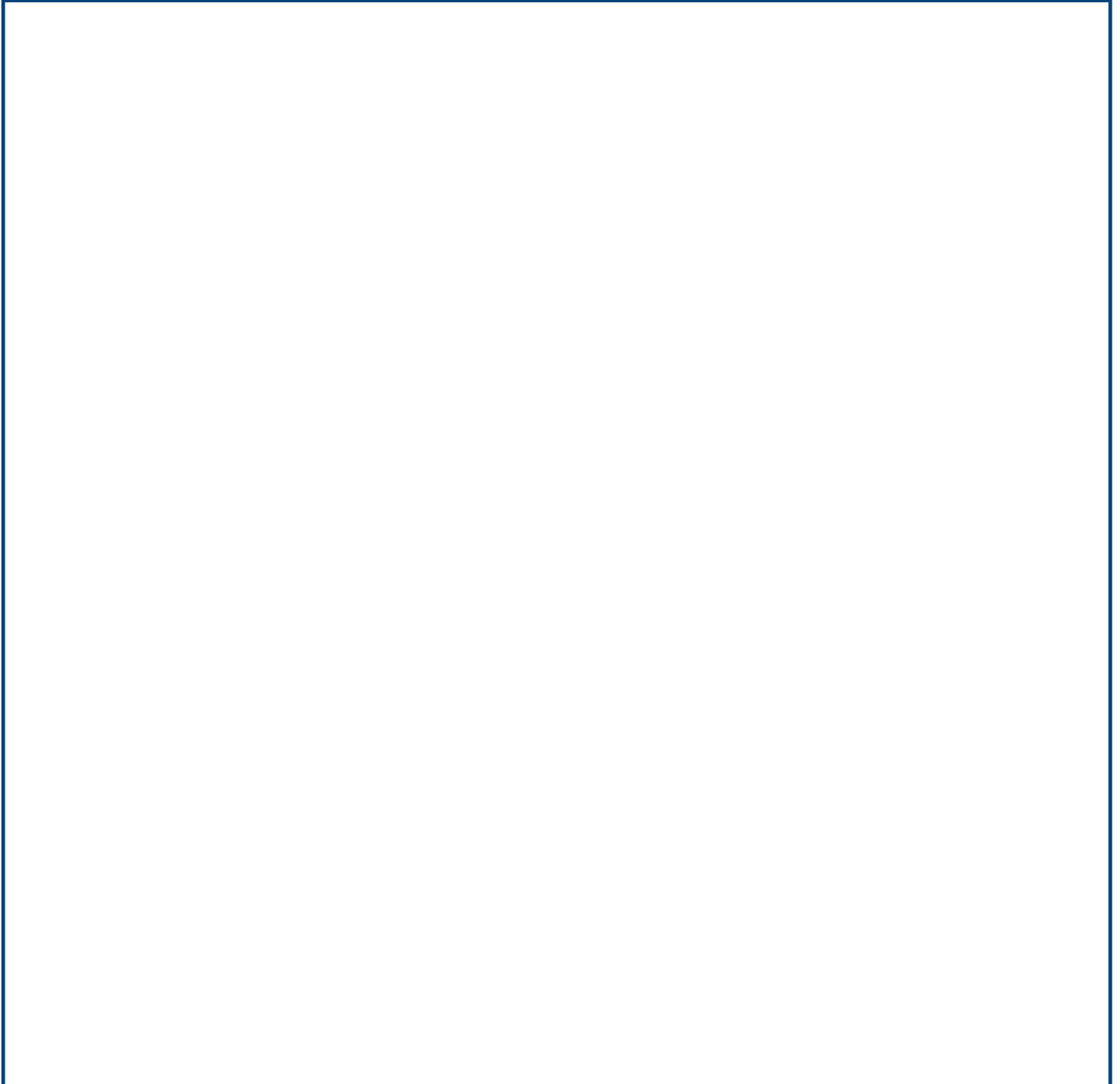

PRODUCT DESCRIPTION:

Worm geared motor fitted for motor coupling
version PAM with sleeve

PRODUCT TYPE: NMRV

CONFIGURATION & DIMENSIONAL VALUES

GR Size	075
RAP Ratio	1:1
PAM Input PAM flange	100/112 B5
ACU Output hole shaft (d)	28
VB Double input shaft	NO
TFU Output flange gear unit 2	NO
DFU Output flange dimension (d)	-
PFU Output flange position	-
AL Output hole shaft (d)	NO
PAL Output shaft position	-
BR Torque arm	NO
PBR Torque arm position	-
CAP Cover	NO
TIP Motor type	NO
GRA Motor size	-
RAF Cooling	-
FC Motor execution	-
TF Break type	-
AF Brake power supply	-
COP Terminal box cover	-
CVE Fan cover	-
MOR Terminal box cover position	-
A	120
AC	-
B	50
B1	8
BB	8(10)
BM	8
BM1	-
D	28(35)
D1	24

PRODUCT DESCRIPTION:

Worm geared motor fitted for motor coupling
version PAM with sleeve

PRODUCT TYPE: NMRV

CONFIGURATION & DIMENSIONAL VALUES

DM	28
DM1	-
E	-
F	M8
FF	-
G	112.5
G1	120
H	86
I	75
K	90
KE	M8x14(8)
L	112
LB	-
LL	-
M	115
N	95
N1	57
O	11.5
P	140
PM	250
PM1	-
Q	93
R	119
S	10
T	40
T1	27
TM	31.3
TM1	-
TT	31.3(38.3)
V	60
W	45°

2D VIEW PRA

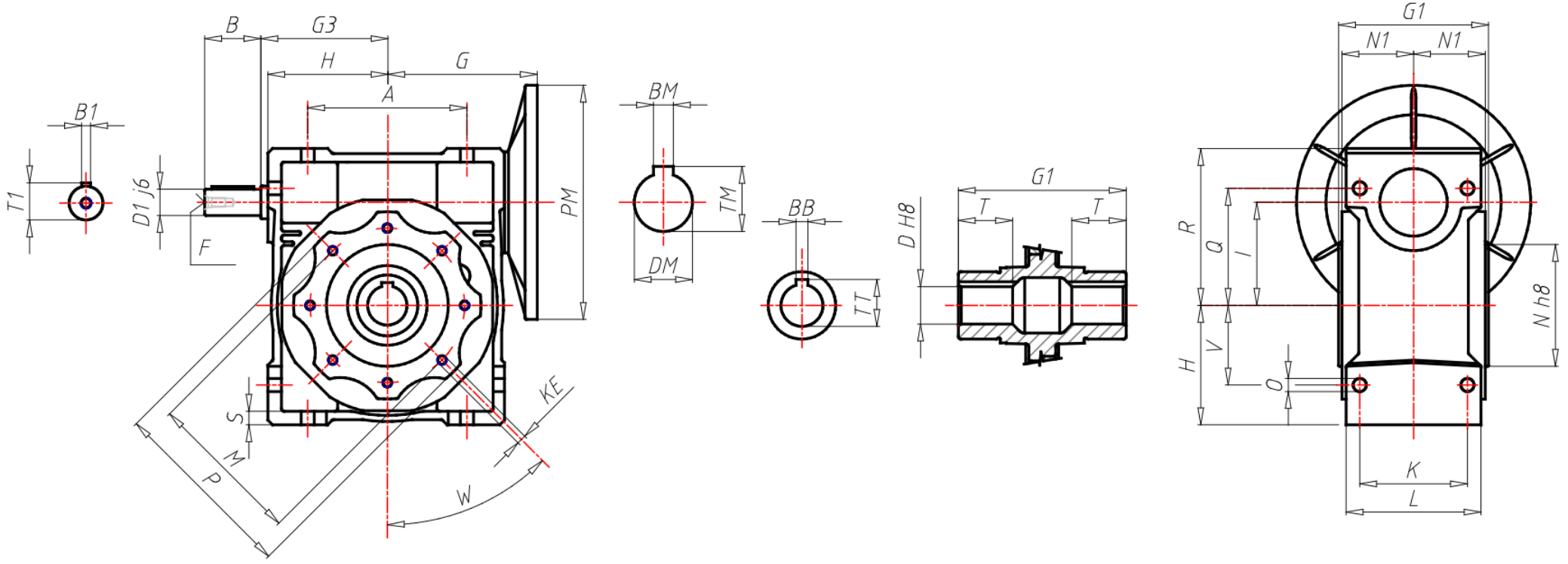

PRODUCT DESCRIPTION:

Worm geared motor fitted for motor coupling version PAM with sleeve

PRODUCT TYPE: NMRV

2D VIEW ACCESSORIES

